

LITHEAUDIO®

BLUETOOTH
CEILING SPEAKER

INSTRUCTION MANUAL

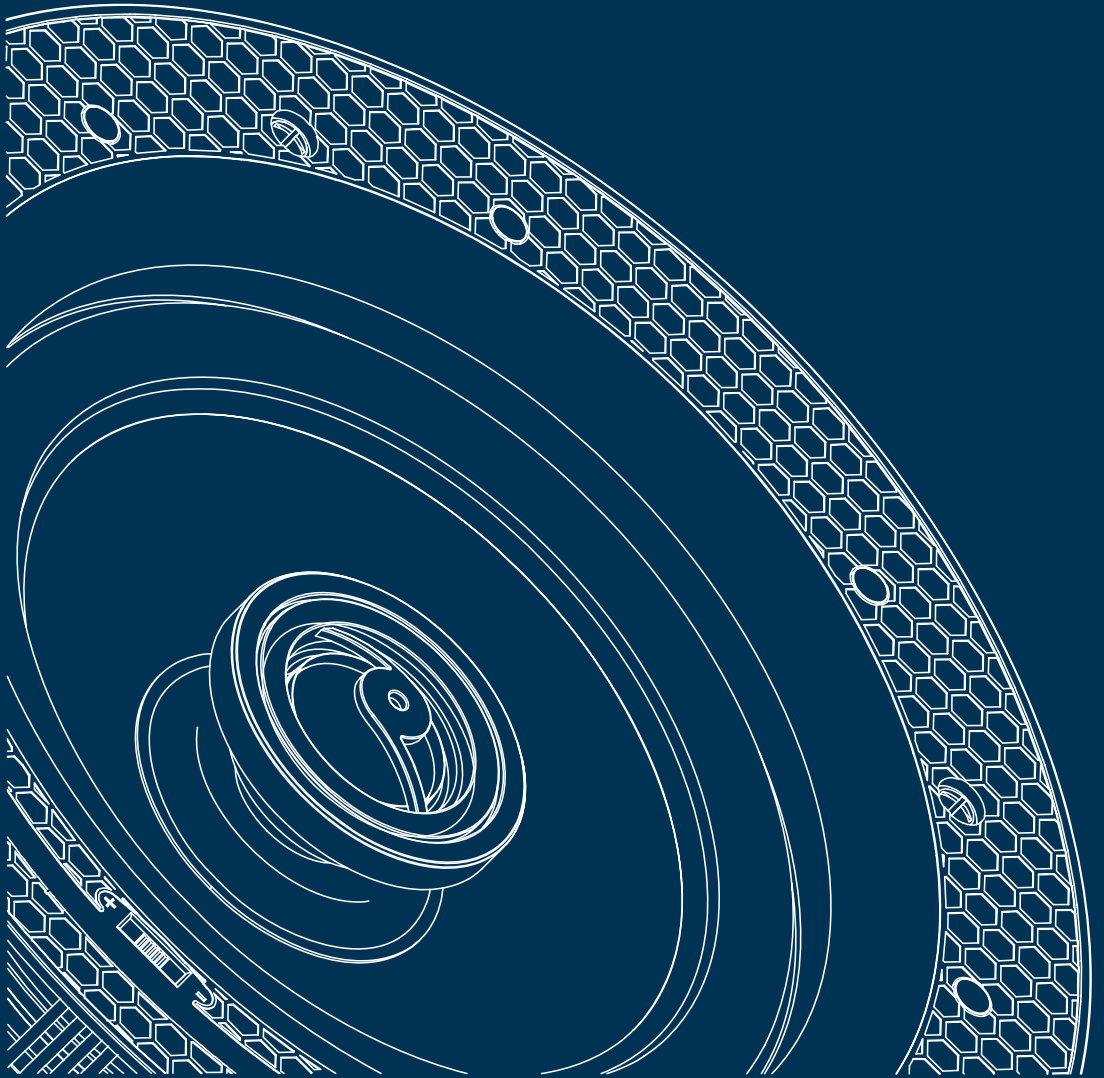

THANK YOU FOR CHOOSING LITHE AUDIO

Innovative design and advanced engineering come as standard in our LBT series of wireless Bluetooth ceiling speakers. Designed for easy installation and high quality sound, within minutes each room is setup and ready. This manual details the installation of LBT series speakers within conventional stud and sheetrock (Joist and plasterboard) ceilings.

IMPORTANT SAFETY WARNING

Before use please read completely and use in accordance with these safety instructions. Before commencing any electrical work ensure the supply is switched OFF at the mains. Either by switching off the consumer unit or by removing the appropriate fuse. This product should be installed in accordance with the relevant sections of the building regulations code and in accordance with the latest edition of IEE regulations (BS 7671).

If the unit is to be used as a replacement for an existing product, remove the existing unit from its location and disconnect the wiring. Connect the wires as shown in the diagram. Ensure terminals are properly tightened and ensure no bare wires are visible. When fitting the speaker into the ceiling, ensure no wires are trapped.

READ THE INSTRUCTIONS CAREFULLY BEFORE STARTING THE INSTALLATION PROCESS AND KEEP THEM SAFE FOR FUTURE REFERENCE.

- Failure to follow the instructions in this guide voids all warranties on your speakers.
- Warning: Do not use the product in water.
- Warning: Do not install speaker directly above any heat sources such as radiators, or other apparatus that produce heat.
- Warning: To reduce the risk of fire or electric shock, do not expose this speaker to rain or moisture (directly above bath or shower area) or in Bathroom Zone 0 or Zone 1.
- Protect the power cable from being damaged, do not over stretch cable.
- Only use attachments/accessories specified by the manufacturer Lithe Audio.
- Turn off the power to the speaker when unused for long periods of time.
- A Fire and Acoustic speaker hood must be used in accordance with UK building and IEE Regulations with a fire rating of up to 60 minutes, is Parts B, L, C and E compliant.
- Do not open the back cover to the speaker as this protects the PCB, doing so will invalidate the warranty and could cause electric shock.
- Ensure speaker location is free from obstructions such as electrical conduit, HVAC ducts or Water lines.

BOX CONTENTS

Please ensure you read the entire instruction manual carefully before you commence any work. Carefully unpack the speakers from the packaging. Please check to ensure all the parts shown below are included.

If any parts of the speaker appear damaged, please contact your dealer/reseller immediately or contact info@litheaudio.com for contact details.

MODEL LBT I OR LBT I/IP

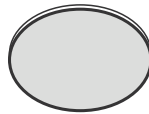
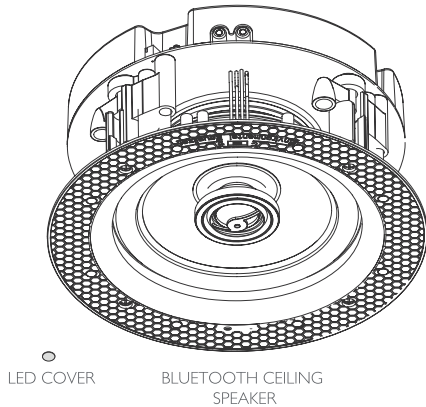

SPEAKER GRILLE

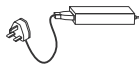

POWER ADAPTOR

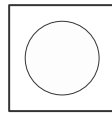

CUTTING GUIDE

PAIR MODELS ALSO INCLUDE

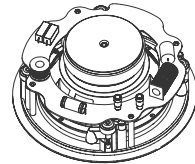

PASSIVE CEILING SPEAKER



5M SPEAKER CABLE

PREPARATION EQUIPMENT YOU WILL NEED

Listed below is the hardware equipment needed to install the speaker, with the addition of a ladder to ensure the installation is done safely. A cutting template is included in the box.



PENCIL



STUD FINDER



SCREWDRIVER



CUTTING SAW



PROTECTIVE EYEWEAR



TAPE



MEASURING TAPE

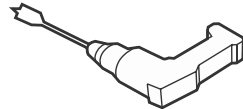

DRILL



SPEAKER CABLE



WIRE CUTTERS

KNOW YOUR SPEAKER

The Lithe Audio LBT range of Bluetooth ceiling wireless speakers have various inputs:

SPEAKER OUTPUT - To connect one additional passive (Slave) speaker (Gold Plated)

LITHE-LINK™ - Connect 2 additional LBT speakers (Total 3 masters & 3 passives)

RCA INPUTS - To connect directly from TV Output, Amazon echo dot, DVD Player etc..

POWER INPUT - To connect (as supplied) transformer Require a in ceiling depth of

Connection Reset Button

LED indicator

Ball joint tweeter to
fine tune direction

Magnets for Cover (8)

Enviromental equalizer
(+/- 3db)

3.8" (95mm)

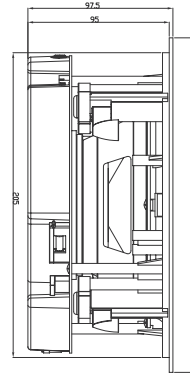

Power input 24V/2.5A

50% Volume capping

Built in Amplifier
& Bluetooth driver

Stereo / bridged

Mono selector

RCA Input

RCA-(Black) RCA+(Red)

Lithe Link connections

Speaker output

R+ (Red) R- (Black)

Dog leg easy install fixings (4)

6.5" (165mm) Kevlar/Polypropylene cone

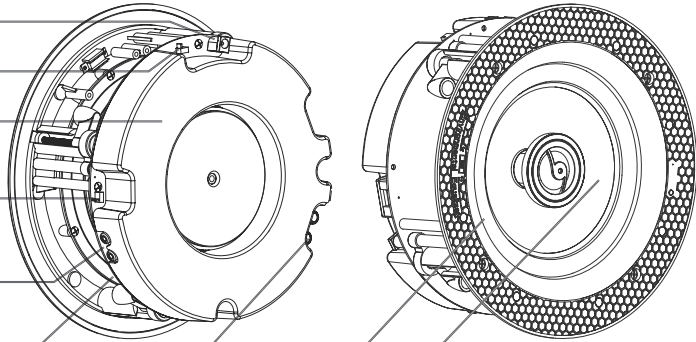

In built over voltage, under voltage, over temperature, and short circuit protection, if there is an electrical fault, the power supply to the amplifier will cut off automatically and restart when the speaker has stabilised.

INSTALLATION

IMPORTANT: BEFORE COMMENCING ANY ELECTRICAL WORK ENSURE THE SUPPLY IS SWITCHED OFF AT THE MAINS. IF YOU ARE UNSURE HOW TO FIT SEEK HELP FROM A PROFESSIONAL ELECTRICIAN/AV INSTALLER

1. Mark out the position of the speaker using a, tape measure and mark using a pencil with the template supplied. Check using a stud finder to make sure no obstruction is present prior to cutting.

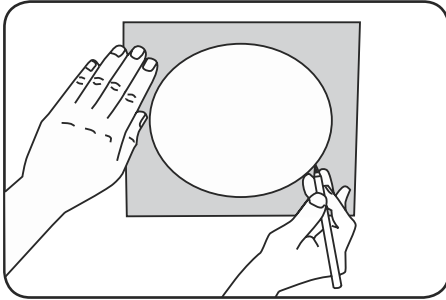

2. Drill a pilot hole and cut the speaker hole using a cutting saw. **Take caution when cutting to keep fingers away from cutting blade and wear protective eyewear.**

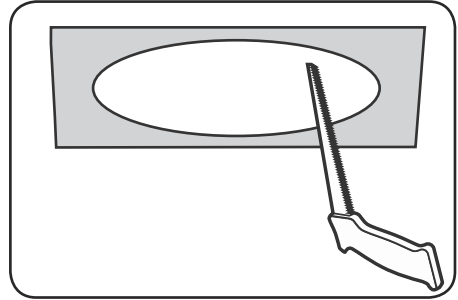

3. Connect the Power lead from the transformer (supplied) to a 13A mains plug socket or terminate to a dedicated 3A fused spur. Ensure the power lead is not overstretched.

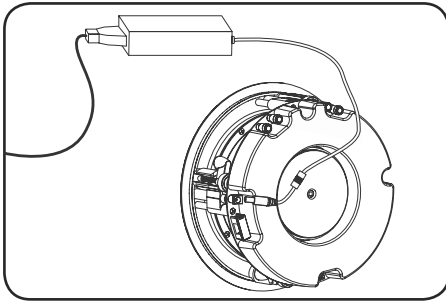

4. Insert speaker into the ceiling then using a screwdriver lock the 4 dog leg fixings to secure the speaker in place, do not over tighten. Attach the magnetic grille to the speaker front.

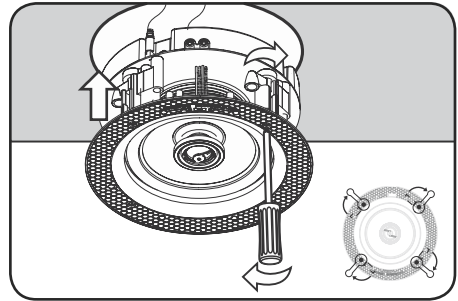

PAINTING THE SPEAKER GRILLE

Do not paint the speaker grilles whilst attached to the speaker. Lithe Audio recommends spray painting using 5 parts thinning agent to 1 part paint. Spray thinly to ensure speaker cover grille holes are not blocked as this will effect the sound quality of the speakers.

INSTALLATIONS IN FIRE-RATED CEILINGS

If you plan to mount your speakers in a fire-rated ceiling, you should purchase a fire hood for the speaker. Visit www.litheaudio.com for more information and recommended hoods.

SETUP AND PAIRING

NOTE: ENSURE THE BLUETOOTH WIRELESS SPEAKER IS CONNECTED TO THE POWER SUPPLY AND TURNED ON.

The Led indicator will flash Blue when ready to pair, turn solid Blue whilst the device is connected to the speaker and music is playing

1. Open the setting menu and select Bluetooth



2. Turn on Bluetooth and search devices

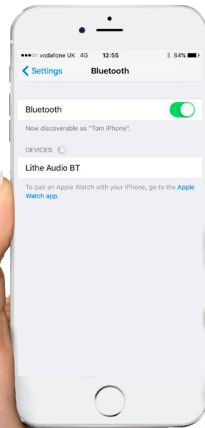

3. Click Lithe Audio BT and if prompted insert PIN "1234" and click Pair



4. The Lithe Audio Bluetooth speaker is now connected to your device ready to play your Music.



CONNECTING DEVICES

If other devices (such as laptops, tablets, phones etc) want to play through the Bluetooth speakers please follow the steps below:

- 1. FIRST CONNECTION:** If device A connects and controls to Bluetooth, Device B cannot search or control the Bluetooth speaker. Device A **MUST** no longer be connected, then Device B can connect and control.
- 2. SECOND CONNECTION:** If Device A is connected and has control, Device B can't connect to Bluetooth until Device A disconnects, enabling Device B to control the Bluetooth speakers.
- 3. ADDITIONAL DEVICES:** If additional Devices want to connect to Bluetooth speakers, a maximum of 2 devices can connect at any one time, only the 1st device to connect controls the speakers. Please ensure devices A or B are disconnected before trying to connect additional devices C, D, E etc...

NOTE: If your connection to speaker is lost, the device maybe out of range (>10m).

To reconnect simply go to the Bluetooth setting menu on your device and reconnect to Lithe Audio BT speaker.

HARD WIRED INPUT - RCA INPUT

To connect other devices that may not have a Bluetooth connection (such as TV, CD players, BluRay player etc) to play through the speakers please follow the steps below:

RCA CONNECTION: To play music via speaker RCA connection connect an RCA cable to the speaker and play through your device. Ensure ALL Bluetooth connections are turned off to be able to play through the speaker. The LED will turn green when playing using RCA.

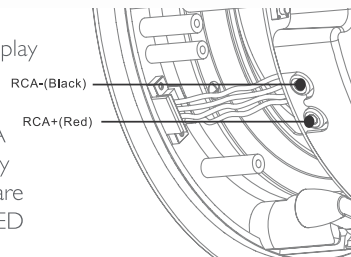

ADDITIONAL SPEAKER - OPTIONAL

PLEASE NOTE: LBT1 DOES NOT INCLUDE PASSIVE SPEAKER

The Lithe Audio Master Bluetooth ceiling speaker is able to connect to and power an additional passive speaker via the speaker output (+/-). Use wire cutters to strip the ends of the speaker cable (if required).

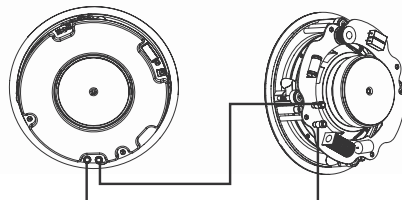

LITHE-LINK™ SETUP

For larger or open plan rooms the Lithe-link feature will allow you to connect up to 3 master speakers and their passive/slaves and play audio from all the speakers at once. Depending on which master speaker you connect to and how the speakers are wired will then determine how many speakers will play.

To connect the speakers you will need a 3.5mm to 3.5mm Jack cable (Not supplied, as length will vary in all situations) Connect one end to the Line OUT (Pink connector block) and the other to the Line IN (Green connector block)

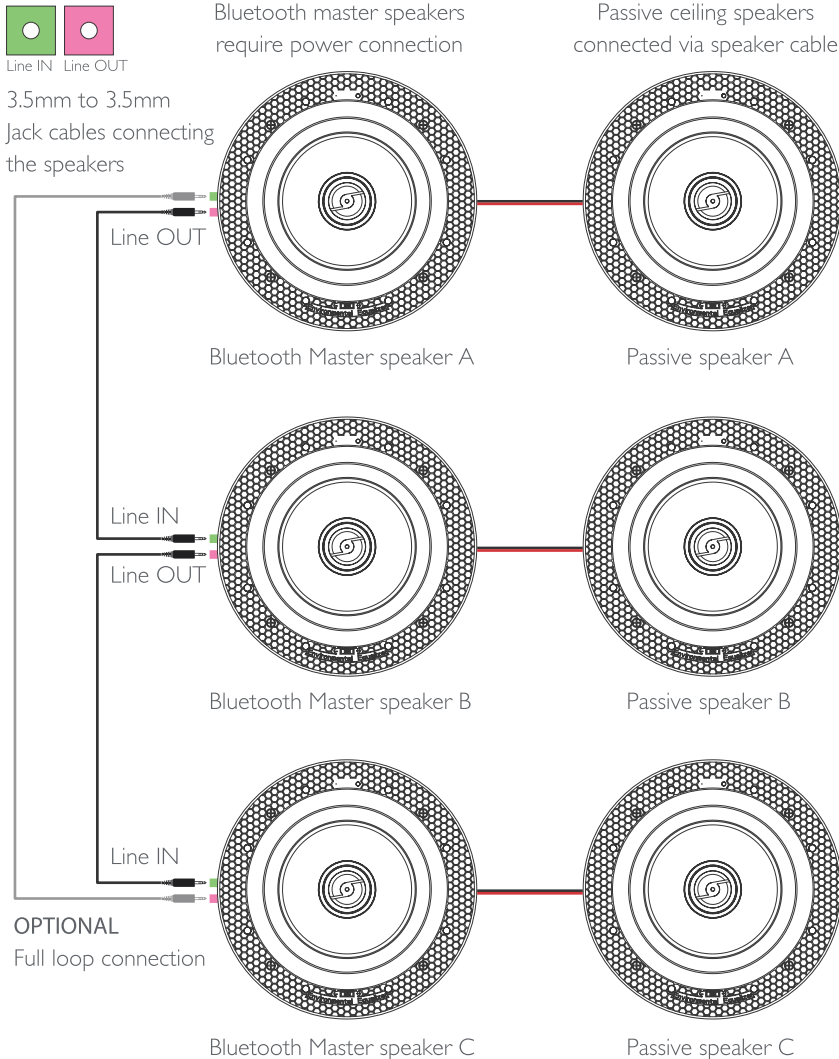

SETUP WITH FULL LOOP CONNECTION

Adding a connection between the first and last master speaker will create a full loop system. When connected which ever master speaker you connect to, all the masters and their passive speakers will play. This will ensure in a large room you will always be in range to a speaker to connect to.

This setup is ideal for open plan rooms where you always want all speakers to play at once.

SETUP WITH OUT FULL LOOP CONNECTION

This configuration will allow you to play only the speaker you connect to and the masters and passives connect after it with the link cable. For Example, if you have a 6 speaker setup and you connect to Speaker A then speakers A, B and C will play. If you connect to Speaker B then only speaker B and C will play. Connect to Speaker C then only Speaker C will play.

This set up is ideal for a floorplan with multiple areas or rooms where you may not always want to play the whole area at once.

LITHE-LINK SPEAKER SETUP OPTIONS

3 SPEAKER SETUP

You will need 2 master speakers and 1 passive speaker.

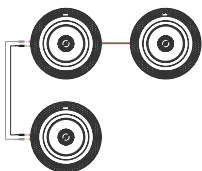

4 SPEAKER SETUP

You will need 2 master speakers and 2 passive speakers.

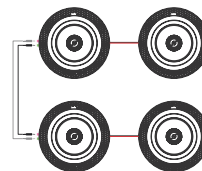

5 SPEAKER SETUP

You will need 3 master speakers and 2 passive speaker.

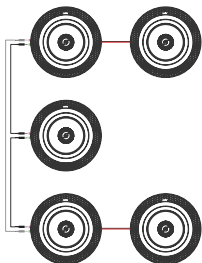

6 SPEAKER SETUP

You will need 3 master speakers and 3 passive speakers.

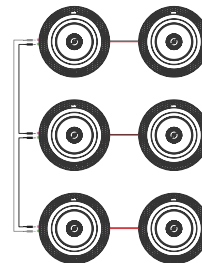

STEREO / MONO SELECTOR

If using a secondary passive speaker you can select if the music is played in Stereo (left and right channels) or in Bridged Mono (single channel). Use the switch on the back of the speaker to select Stereo or Mono output.

VOLUME CAPPING SWITCH

If installing in a children's bedroom, hotel room or commercial space you may wish to cap the volume at 50%. Using the Volume capping switch on the back of the speaker you can select either 100% or 50% max volume output.

LED INDICATOR COVER

To mask the LED indicator, use the LED cover sticker included

CONNECTION RESET BUTTON

Press and hold the 'Reset Button' for 2 seconds to clear the connection memory. All paired devices will be deleted.

SPECIFICATIONS

- Sound Quality THD+N<0.009%, 65Hz-20kHz
- RMS Power: 50W RMS
- Impedance: 8 Ohms
- Sensitivity (1W/1m): 90dB
- Audio Sample Rate: 8Khz
- Line In Analog (RCA), auto-detecting
- Type: Class D (Digital)
- Woofer: 6.5" Kevlar Woven / Polypropylene Cone
- Tweeter: 0.75" Titanium Cone
- Bluetooth System: Bluetooth V4.0
- Frequency Range: 2.4GHz - 2.4832GHz (ISM Band)
- RF Channels: 79 (USA, Japan & EU)
- Wireless Range: Up to 10 metres
- ID Device Name: Lithe Audio
- Power Input Supply : 100 - 240V ~ / 2A
- Transformer Output Supply : DC24V / 2.5A
- Dimensions (W x D) 230 x 95mm (6.5 x 3.8 in)
- Weight 1.75kg (3.85 lbs)
- IP rating: IP44 (Model: LBT1/IP or LBT2/IP only)
- Operating Temperature 0° to 40° C (32° to 104° F)
- Storage Temperature -20° to 70° C (4° to 158° F)
- Standby power: 1.3W / 0.02A
- Connected power: 1.5W / 0.03A
- Playing Music: 2.8W - 10.5W / 0.03A - 0.09A**

* Specifications subject to change without notice.

** Power Consumption depends on the type of music & volume - Increased Bass & volume requires more power loading on the amplifier.

TROUBLESHOOTING

If a problem arises, please try the troubleshooting frequently asked guide below. If the problem is not listed please contact Lithe Audio Customer Service Support on info@litheaudio.com or Call +44 (0) 1293 922 015

Q: Speaker has not been found during setup

A: Please check power cord is correctly connected in to speaker and transformer; Check the blue light is flashing. Press reset button for 5 seconds to reboot the speaker.
Before commencing any electrical work ensure the supply is switched OFF at the mains.

Q: Speaker has failed to connect to Bluetooth

A: Please retry setup and pairing process, follow setup steps 1 - 4 to connect device. Please ensure speaker password is entered correctly. Ensure the device is within 10m range. If this does not work, power down the speaker, wait 20 seconds, then power up again and try again.

Q: Device is connected to Bluetooth speaker but no sound

A: Ensure your device volume is NOT muted, increase the volume or try another audio source

Q: Can the speaker be installed into the bathroom ceiling.

A: The IP rated models 'LBT1/IP' or 'FLC6/IP' can be installed in zone 2 or 3 of a bathroom. Ensure you read the safety precautions on page 1 before installation. **Warning:** Do not use the product in water or directly above the bath or shower area.

For further queries and support questions please visit www.litheaudio.com/support

REGULATION INFORMATION

EUROPE

LitheAudio declares that this product herewith complies with the requirements of the EMC Directive 2004/108/EC, Low Voltage directive 2006/95/EC, Eco-Design Directive 2005/32/EC, RoHS Directive 2011/65/EU and the R&TTE Directive 1999/5/EC when installed and used in accordance with the manufacturer's instructions. A copy of the full Declaration of Conformance may be obtained at www.litheaudio.com/support/policies.

Lithe Audio Speakers have a standby mode or remove the power cord from the AC mains.

RECYCLING INFORMATION

This symbol on the product or on its packaging indicates that this product shall not be treated as household waste.

Instead please deliver it to the applicable collection point for the recycling of electrical and electronic equipment. By recycling this product correctly, you will help conserve natural resources and prevent potential negative environmental consequences. For more detailed information about recycling of this product, please contact your local council office, your household waste disposal service or the shop where you purchased the product(s) from.

LITHEAUDIO®

2 YEAR GUARANTEE

This Ceiling Speaker is of excellent quality and construction. However, if any defects in materials or workmanship do appear during the guarantee period, we will, at our discretion, either repair or replace the defective parts, free of charge, subject to the terms and conditions of our Guarantee shown below.

This Guarantee covers both parts and labour. Carriage is not included.

This Guarantee provides benefits which are additional to, and do not affect, your statutory rights. This Guarantee does not cover the cost of returning the product to the dealer from whom it was purchased or to ourselves. This Guarantee applies only to products sold and located in mainland Great Britain. It does not cover liability in respect of or replacement of plugs, cables or fuses and also does not cover defects due to:

- Failure to use or maintain product in accordance with Lithe Audio instructions.
- The product being connected to an unsuitable electricity supply.
- Accidental damage to or abuse or misuse of the product.
- Product modification, except by Lithe Audio or approved agent.
- Dismantling of or interference with the product.

Before returning any product under this Guarantee, please check that:

- You have followed the product instructions correctly.
- Your mains electricity supply is functional.
- The defect is not due to a blown fuse.

If you wish to claim under this guarantee you should:

- Send the product, postage or carriage paid, to the dealer from whom it was purchased or to Lithe Audio direct.
- Ensure that the product is clean and packed carefully (preferably in its original carton).
- Enclose details of your name, address and telephone number and when and where the product was purchased, together with proof of purchase (e.g. a invoice or till receipt).
- Give exact details of the nature of the defect.

This Guarantee does not cover any other claims whatsoever, including, without limitation, any liability for incidental, indirect or consequential damage, nor does it cover any claims for conversion or modification or for the costs of repair carried out by any third party without the prior consent of Lithe Audio. If replacement parts are fitted to the product this will not extend the period of the Guarantee. For further advice contact the Lithe Audio customer services.



Lithe Audio products marked with the CE mark comply with the EC Low Voltage Directive: 73/23/EEC, Electromagnetic Compatibility Directive 89/336/EEC

WWW.LITHEAUDIO.COM
TEL: 01293 922 015 EMAIL: INFO@LITHEAUDIO.COM



LBTIBGBE